

Ultracompact, 1.5 A Thermoelectric Cooler (TEC) Controller

FEATURES

- ▶ Patented high efficiency single inductor architecture
- ▶ Integrated low $R_{DS(ON)}$ MOSFETs for the TEC controller
- ▶ TEC voltage and current operation monitoring
- ▶ No external sense resistor required
- ▶ Independent TEC heating and cooling current limit settings
- ▶ Programmable maximum TEC voltage
- ▶ 2.0 MHz PWM driver switching frequency
- ▶ External synchronization
- ▶ Two integrated, zero drift, rail-to-rail chopper amplifiers
- ▶ Capable of NTC or RTD thermal sensors
- ▶ 2.50 V reference output with 1% accuracy
- ▶ Temperature lock indicator
- ▶ Available in a 25-ball, 2.5 mm × 2.5 mm WLCSP or in a 24-lead, 4 mm × 4 mm LFCSP
- ▶ AEC-Q100 qualified for automotive applications

APPLICATIONS

- ▶ TEC temperature control
- ▶ Optical modules
- ▶ Optical fiber amplifiers
- ▶ Optical networking systems
- ▶ Instruments requiring TEC temperature control

GENERAL DESCRIPTION

The ADN8834¹ is a monolithic TEC controller with an integrated TEC controller. It has a linear power stage, a pulse-width modulation (PWM) power stage, and two zero-drift, rail-to-rail operational amplifiers. The linear controller works with the PWM driver to control the internal power MOSFETs in an H-bridge configuration. By measuring the thermal sensor feedback voltage and using the integrated operational amplifiers as a proportional integral differential (PID) compensator to condition the signal, the ADN8834 drives current through a TEC to settle the temperature of a laser diode or a passive component attached to the TEC module to the programmed target temperature.

The ADN8834 supports negative temperature coefficient (NTC) thermistors as well as positive temperature coefficient (PTC) resistive temperature detectors (RTD). The target temperature is set as an analog voltage input either from a digital-to-analog converter (DAC) or from an external resistor divider.

The temperature control loop of the ADN8834 is stabilized by PID compensation utilizing the built in, zero drift chopper amplifiers. The internal 2.50 V reference voltage provides a 1% accurate output

¹ Product is covered by U.S. Patent No. 6,486,643.

Rev. C

DOCUMENT FEEDBACK

TECHNICAL SUPPORT

Information furnished by Analog Devices is believed to be accurate and reliable "as is". However, no responsibility is assumed by Analog Devices for its use, nor for any infringements of patents or other rights of third parties that may result from its use. Specifications subject to change without notice. No license is granted by implication or otherwise under any patent or patent rights of Analog Devices. Trademarks and registered trademarks are the property of their respective owners.

FUNCTIONAL BLOCK DIAGRAM

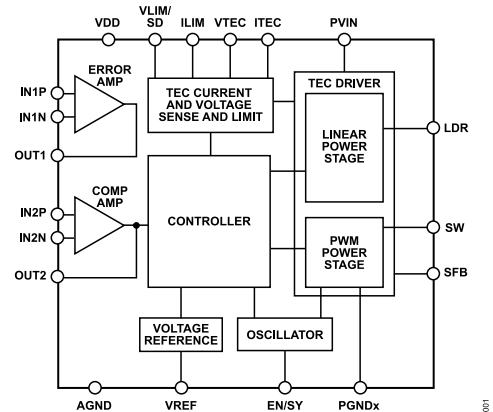

Figure 1.

that is used to bias a thermistor temperature sensing bridge as well as a voltage divider network to program the maximum TEC current and voltage limits for both the heating and cooling modes. With the zero drift chopper amplifiers, extremely good long-term temperature stability is maintained via an autonomous analog temperature control loop.

Table 1. TEC Family Models

Device No.	MOSFET	Thermal Loop	Package
ADN8831	Discrete	Digital/analog	LFCSP (CP-32-7)
ADN8833	Integrated	Digital	WLCSP (CB-25-7), LFCSP (CP-24-15)
ADN8834	Integrated	Digital/analog	WLCSP (CB-25-7), LFCSP (CP-24-15)

TABLE OF CONTENTS

Features.....	1	Maximum TEC Voltage Limit.....	17
Applications.....	1	Maximum TEC Current Limit.....	17
Functional Block Diagram.....	1	Applications Information.....	19
General Description.....	1	Signal Flow.....	19
Specifications.....	3	Thermistor Setup.....	19
Absolute Maximum Ratings.....	7	Thermistor Amplifier (Chopper 1).....	19
Thermal Resistance.....	7	PID Compensation Amplifier (Chopper 2).....	20
ESD Caution.....	7	MOSFET Driver Amplifiers.....	20
Pin Configurations and Function Descriptions.....	8	PWM Output Filter Requirements.....	21
Typical Performance Characteristics.....	9	Input Capacitor Selection.....	22
Detailed Functional Block Diagram.....	13	Power Dissipation.....	22
Theory of Operation.....	14	PCB Layout Guidelines.....	24
Analog PID Control.....	15	Block Diagrams and Signal Flow.....	24
Digital PID Control.....	15	Guidelines for Reducing Noise and	
Powering the Controller.....	15	Minimizing Power Loss.....	24
Enable and Shutdown	16	Example PCB Layout Using Two Layers.....	25
Oscillator Clock Frequency.....	16	Outline Dimensions.....	27
Temperature Lock Indicator (LFCSP Only).....	16	Ordering Guide.....	27
Soft Start on Power-Up.....	16	Evaluation Boards.....	27
TEC Voltage/Current Monitor.....	17	Automotive Products.....	28

REVISION HISTORY**3/2022—Rev. B to Rev. C**

Changes to Features Section.....	1
Changes to Figure 37, Figure 38, and Figure 39.....	21
Updated Outline Dimensions.....	27
Changes to Ordering Guide.....	27
Added Automotive Products Section.....	28

SPECIFICATIONS

$V_{IN} = 2.7\text{ V to }5.5\text{ V}$, $T_J = -40^\circ\text{C to }+125^\circ\text{C}$ for minimum/maximum specifications, and $T_A = 25^\circ\text{C}$ for typical specifications, unless otherwise noted.

Table 2.

Parameter	Symbol	Test Conditions/Comments	Min	Typ	Max	Unit
POWER SUPPLY						
Driver Supply Voltage	V_{PVIN}		2.7		5.5	V
Controller Supply Voltage	V_{VDD}		2.7		5.5	V
Supply Current	I_{VDD}	PWM not switching		3.3	5	mA
Shutdown Current	I_{SD}	EN/SY = AGND or VLIM/SD = AGND		350	700	μA
Undervoltage Lockout (UVLO)	V_{UVLO}	V_{VDD} rising	2.45	2.55	2.65	V
UVLO Hysteresis	$UVLO_{HYST}$		80	90	100	mV
REFERENCE VOLTAGE	V_{VREF}	$I_{VREF} = 0\text{ mA to }10\text{ mA}$	2.475	2.50	2.525	V
LINEAR OUTPUT						
Output Voltage	V_{LDR}	$I_{LDR} = 0\text{ A}$		0		V
Low				V_{PVIN}		V
High						V
Maximum Source Current	I_{LDR_SOURCE}	$T_J = -40^\circ\text{C to }+105^\circ\text{C}$ $T_J = -40^\circ\text{C to }+125^\circ\text{C}$	1.5 1.2			A A
Maximum Sink Current	I_{LDR_SINK}	$T_J = -40^\circ\text{C to }+105^\circ\text{C}$ $T_J = -40^\circ\text{C to }+125^\circ\text{C}$			1.5 1.2	A A
On Resistance		$I_{LDR} = 0.6\text{ A}$				
P-MOSFET	$R_{DS_PL(ON)}$	WLCSP, $V_{PVIN} = 5.0\text{ V}$ WLCSP, $V_{PVIN} = 3.3\text{ V}$ LFCSP, $V_{PVIN} = 5.0\text{ V}$ LFCSP, $V_{PVIN} = 3.3\text{ V}$		35 44 50 55	50 60 65 75	m Ω m Ω m Ω m Ω
N-MOSFET	$R_{DS_NL(ON)}$	WLCSP, $V_{PVIN} = 5.0\text{ V}$ WLCSP, $V_{PVIN} = 3.3\text{ V}$ LFCSP, $V_{PVIN} = 5.0\text{ V}$ LFCSP, $V_{PVIN} = 3.3\text{ V}$		31 40 45 50	50 55 70 80	m Ω m Ω m Ω m Ω
Leakage Current						
P-MOSFET	$I_{LDR_P_LKG}$			0.1	10	μA
N-MOSFET	$I_{LDR_N_LKG}$			0.1	10	μA
Linear Amplifier Gain	A_{LDR}			40		V/V
LDR Short-Circuit Threshold	$I_{LDR_SH_GNDL}$ $I_{LDR_SH_PVIN(L)}$	LDR short to PGNDL, enter hiccup LDR short to PVIN, enter hiccup		2.2 -2.2		A A
Hiccup Cycle	T_{HICCUP}			15		ms
PWM OUTPUT						
Output Voltage	V_{SFB}	$I_{SFB} = 0\text{ A}$				V
Low				$0.06 \times V_{PVIN}$		V
High				$0.93 \times V_{PVIN}$		V
Maximum Source Current	I_{SW_SOURCE}	$T_J = -40^\circ\text{C to }+105^\circ\text{C}$ $T_J = -40^\circ\text{C to }+125^\circ\text{C}$	1.5 1.2			A A
Maximum Sink Current	I_{SW_SINK}	$T_J = -40^\circ\text{C to }+105^\circ\text{C}$ $T_J = -40^\circ\text{C to }+125^\circ\text{C}$			1.5 1.2	A A
On Resistance		$I_{SW} = 0.6\text{ A}$				
P-MOSFET	$R_{DS_PS(ON)}$	WLCSP, $V_{PVIN} = 5.0\text{ V}$ WLCSP, $V_{PVIN} = 3.3\text{ V}$ LFCSP, $V_{PVIN} = 5.0\text{ V}$ LFCSP, $V_{PVIN} = 3.3\text{ V}$		47 60 60 70	65 80 80 95	m Ω m Ω m Ω m Ω
N-MOSFET	$R_{DS_NS(ON)}$	WLCSP, $V_{PVIN} = 5.0\text{ V}$		40	60	m Ω

SPECIFICATIONS

Table 2.

Parameter	Symbol	Test Conditions/Comments	Min	Typ	Max	Unit	
Leakage Current		WLCSP, $V_{PVIN} = 3.3\text{ V}$		45	65	m Ω	
		LFCSP, $V_{PVIN} = 5.0\text{ V}$		45	75	m Ω	
		LFCSP, $V_{PVIN} = 3.3\text{ V}$		55	85	m Ω	
		P-MOSFET	$I_{SW_P_LKG}$		0.1	10	μA
		N-MOSFET	$I_{SW_N_LKG}$		0.1	10	μA
		SW Node Rise Time ¹	t_{SW_R}	$C_{SW} = 1\text{ nF}$		1	ns
PWM Duty Cycle ²	D_{SW}		6		93	%	
SFB Input Bias Current	I_{SFB}			1	2	μA	
PWM OSCILLATOR							
Internal Oscillator Frequency	f_{OSC}	EN/SY high	1.85	2.0	2.15	MHz	
EN/SY Input Voltage							
Low	V_{EN/SY_LOW}				0.8	V	
High	V_{EN/SY_HIGH}		2.1			V	
External Synchronization Frequency	f_{SYNC}		1.85		3.25	MHz	
Synchronization Pulse Duty Cycle	D_{SYNC}		10		90	%	
EN/SY Rising to PWM Rising Delay	t_{SYNC_PWM}			50		ns	
EN/SY to PWM Lock Time	t_{SY_LOCK}	Number of SYNC cycles			10	Cycles	
EN/SY Input Current	$I_{EN/SY}$			0.3	0.5	μA	
Pull-Down Current				0.3	0.5	μA	
ERROR/COMPENSATION AMPLIFIERS							
Input Offset Voltage	V_{OS1}	$V_{CM1} = 1.5\text{ V}, V_{OS1} = V_{IN1P} - V_{IN1N}$		10	100	μV	
	V_{OS2}	$V_{CM2} = 1.5\text{ V}, V_{OS2} = V_{IN2P} - V_{IN2N}$		10	100	μV	
Input Voltage Range	V_{CM1}, V_{CM2}		0		V_{VDD}	V	
Common-Mode Rejection Ratio (CMRR)	$CMRR_1, CMRR_2$	$V_{CM1}, V_{CM2} = 0.2\text{ V to } V_{VDD} - 0.2\text{ V}$		120		dB	
Output Voltage							
High	V_{OH1}, V_{OH2}		$V_{VDD} - 0.04$			V	
Low	V_{OL1}, V_{OL2}				10	mV	
Power Supply Rejection Ratio (PSRR)	$PSRR_1, PSRR_2$			120		dB	
Output Current	I_{OUT1}, I_{OUT2}	Sourcing and sinking	5			mA	
Gain Bandwidth Product ¹	GBW_1, GBW_2	$V_{OUT1}, V_{OUT2} = 0.5\text{ V to } V_{VDD} - 1\text{ V}$		2		MHz	
TEC CURRENT LIMIT							
ILIM Input Voltage Range							
Cooling	V_{ILIMC}		1.3		$V_{VREF} - 0.2$	V	
Heating	V_{ILIMH}		0.2		1.2	V	
Current-Limit Threshold							
Cooling	V_{ILIMC_TH}	$V_{ITEC} = 0.5\text{ V}$	1.98	2.0	2.02	V	
Heating	V_{ILIMH_TH}	$V_{ITEC} = 2\text{ V}$	0.48	0.5	0.52	V	
ILIM Input Current							
Heating	I_{ILIMH}		-0.2		+0.2	μA	
Cooling	I_{ILIMC}	Sourcing current	37.5	40	42.5	μA	
Cooling to Heating Current Detection Threshold	$I_{COOL_HEAT_TH}$			40		mA	
TEC VOLTAGE LIMIT							
Voltage Limit Gain	A_{VLIM}	$(V_{DRL} - V_{SFB})/V_{VLIM}$		2		V/V	
VLIM/SD Input Voltage Range ¹	V_{VLIM}		0.2		$V_{VDD}/2$	V	
VLIM/SD Input Current							
Cooling	I_{ILIMC}	$V_{OUT2} < V_{VREF}/2$	-0.2		+0.2	μA	

SPECIFICATIONS

Table 2.

Parameter	Symbol	Test Conditions/Comments	Min	Typ	Max	Unit
Heating	I_{LIMH}	$V_{OUT2} > V_{VREF}/2$, sinking current	8	10	12.2	μA
TEC CURRENT MEASUREMENT (WLCSP)						
Current Sense Gain	R_{CS}	$V_{PVIN} = 3.3 V$ $V_{PVIN} = 5 V$		0.525 0.535		V/A V/A
Current Measurement Accuracy	I_{LDR_ERROR}	$700 mA \leq I_{LDR} \leq 1.5 A, V_{PVIN} = 3.3 V$ $800 mA \leq I_{LDR} \leq 1.5 A, V_{PVIN} = 5 V$	-10 -10		+10 +10	% %
ITEC Voltage Accuracy	$V_{ITEC_@_700_mA}$	$V_{PVIN} = 3.3 V$, cooling, $V_{VREF}/2 + I_{LDR} \times R_{CS}$	1.597	1.618	1.649	V
	$V_{ITEC_@_700_mA}$	$V_{PVIN} = 3.3 V$, heating, $V_{VREF}/2 - I_{LDR} \times R_{CS}$	0.846	0.883	0.891	V
	$V_{ITEC_@_800_mA}$	$V_{PVIN} = 5 V$, cooling, $V_{VREF}/2 + I_{LDR} \times R_{CS}$	1.657	1.678	1.718	V
	$V_{ITEC_@_800_mA}$	$V_{PVIN} = 5 V$, heating, $V_{VREF}/2 - I_{LDR} \times R_{CS}$	0.783	0.822	0.836	V
TEC CURRENT MEASUREMENT (LFCSP)						
Current Sense Gain	R_{CS}	$V_{PVIN} = 3.3 V$ $V_{PVIN} = 5 V$		0.525 0.525		V/A V/A
Current Measurement Accuracy	I_{LDR_ERROR}	$700 mA \leq I_{LDR} \leq 1 A, V_{PVIN} = 3.3 V$ $800 mA \leq I_{LDR} \leq 1 A, V_{PVIN} = 5 V$	-15 -15		+15 +15	% %
ITEC Voltage Accuracy	$V_{ITEC_@_700_mA}$	$V_{PVIN} = 3.3 V$, cooling, $V_{VREF}/2 + I_{LDR} \times R_{CS}$	1.374	1.618	1.861	V
	$V_{ITEC_@_700_mA}$	$V_{PVIN} = 3.3 V$, heating, $V_{VREF}/2 - I_{LDR} \times R_{CS}$	0.750	0.883	1.015	V
	$V_{ITEC_@_800_mA}$	$V_{PVIN} = 5 V$, cooling, $V_{VREF}/2 + I_{LDR} \times R_{CS}$	1.419	1.678	1.921	V
	$V_{ITEC_@_800_mA}$	$V_{PVIN} = 5 V$, heating, $V_{VREF}/2 - I_{LDR} \times R_{CS}$	0.705	0.830	0.955	V
ITEC Voltage Output Range	V_{ITEC}	$I_{TEC} = 0 A$	0		$V_{VREF} - 0.05$	V
ITEC Bias Voltage	V_{ITEC}	$I_{LDR} = 0 A$	1.210	1.250	1.285	V
Maximum ITEC Output Current	I_{ITEC}		-2		+2	mA
TEC VOLTAGE MEASUREMENT						
Voltage Sense Gain	A_{VTEC}		0.24	0.25	0.26	V/V
Voltage Measurement Accuracy	$V_{VTEC_@_1 V}$	$V_{LDR} - V_{SFB} = 1 V, V_{VREF}/2 + A_{VTEC} \times (V_{LDR} - V_{SFB})$	1.475	1.50	1.525	V
VTEC Output Voltage Range	V_{VTEC}		0.005		2.625	V
VTEC Bias Voltage	V_{VTEC_B}	$V_{LDR} = V_{SFB}$	1.225	1.250	1.285	V
Maximum VTEC Output Current	R_{VTEC}		-2		+2	mA
TEMPERATURE GOOD (LFCSP ONLY)						
TMPGD Low Output Voltage	V_{TMPGD_LO}	No load			0.4	V
TMPGD High Output Voltage	V_{TMPGD_HO}	No load	2.0			V
TMPGD Output Low Impedance	R_{TMPGD_LOW}			25		Ω
TMPGD Output High Impedance	R_{TMPGD_LOW}			50		Ω
High Threshold	V_{OUT1_THH}	IN2N tied to OUT2, $V_{IN2P} = 1.5 V$		1.54	1.56	V
Low Threshold	V_{OUT1_THL}	IN2N tied to OUT2, $V_{IN2P} = 1.5 V$	1.40	1.46		V
INTERNAL SOFT START						
Soft Start Time	t_{SS}			150		ms
VLIM/SD SHUTDOWN						
VLIM/SD Low Voltage Threshold	V_{VLIM/SD_THL}				0.07	V
THERMAL SHUTDOWN						
Thermal Shutdown Threshold	T_{SHDN_TH}			170		$^{\circ}C$

SPECIFICATIONS**Table 2.**

Parameter	Symbol	Test Conditions/Comments	Min	Typ	Max	Unit
Thermal Shutdown Hysteresis	T _{SHDN_HYS}			17		°C

¹ This specification is guaranteed by design.

² This specification is guaranteed by characterization.

ABSOLUTE MAXIMUM RATINGS

Table 3.

Parameter	Rating
PVIN to PGNDL (WLCSP)	-0.3 V to +5.75 V
PVIN to PGNDL (LFCSP)	-0.3 V to +5.75 V
PVINL to PGNDL (WLCSP)	-0.3 V to +5.75 V
PVINL to PGNDL (LFCSP)	-0.3 V to +5.75 V
LDR to PGNDL (WLCSP)	-0.3 V to V_{PVIN}
LDR to PGNDL (LFCSP)	-0.3 V to V_{PVINL}
SW to PGNDL	-0.3 V to +5.75 V
SFB to AGND	-0.3 V to V_{VDD}
AGND to PGNDL	-0.3 V to +0.3 V
AGND to PGNDL	-0.3 V to +0.3 V
VLIM/SD to AGND	-0.3 V to V_{VDD}
ILIM to AGND	-0.3 V to V_{VDD}
VREF to AGND	-0.3 V to +3 V
VDD to AGND	-0.3 V to +5.75 V
IN1P to AGND	-0.3 V to V_{VDD}
IN1N to AGND	-0.3 V to V_{VDD}
OUT1 to AGND	-0.3 V to +5.75 V
IN2P to AGND	-0.3 V to V_{VDD}
IN2N to AGND	-0.3 V to V_{VDD}
OUT2 to AGND	-0.3 V to +5.75 V
EN/SY to AGND	-0.3 V to V_{VDD}
ITEC to AGND	-0.3 V to +5.75 V
VTEC to AGND	-0.3 V to +5.75 V
Maximum Current	
VREF to AGND	20 mA
OUT1 to AGND	50 mA
OUT2 to AGND	50 mA
ITEC to AGND	50 mA
VTEC to AGND	50 mA
Junction Temperature	125°C
Storage Temperature Range	-65°C to +150°C
Lead Temperature (Soldering, 10 sec)	260°C

Stresses at or above those listed under Absolute Maximum Ratings may cause permanent damage to the product. This is a stress rating only; functional operation of the product at these or any other conditions above those indicated in the operational section of this specification is not implied. Operation beyond the maximum operating conditions for extended periods may affect product reliability.

THERMAL RESISTANCE

θ_{JA} is specified for the worst-case conditions, that is, a device soldered in a circuit board for surface-mount packages, and is based on a 4-layer standard JEDEC board.

Table 4.

Package Type	θ_{JA}	θ_{JC}	Unit
25-Ball WLCSP	48	0.6	°C/W
24-Lead LFCSP	37	1.65	°C/W

ESD CAUTION



ESD (electrostatic discharge) sensitive device. Charged devices and circuit boards can discharge without detection. Although this product features patented or proprietary protection circuitry, damage may occur on devices subjected to high energy ESD. Therefore, proper ESD precautions should be taken to avoid performance degradation or loss of functionality.

PIN CONFIGURATIONS AND FUNCTION DESCRIPTIONS

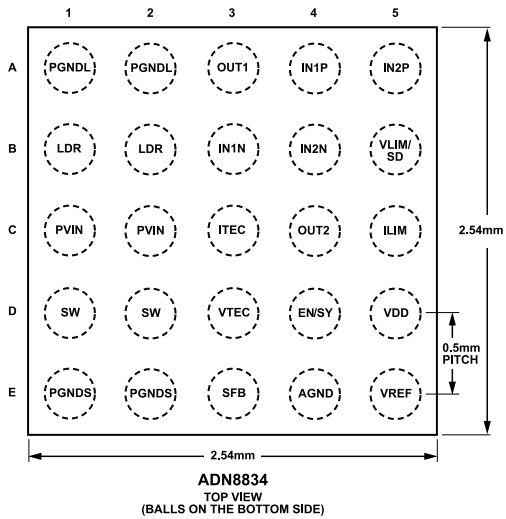

Figure 2. WLCSP Pin Configuration (Top View)

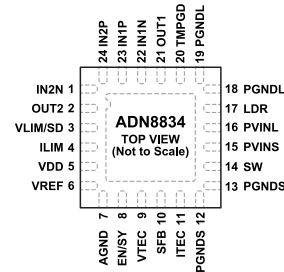

Figure 3. LFCSP Pin Configuration (Top View)

Table 5. Pin Function Descriptions

Pin No.		Mnemonic	Description
WLCSP	LFCSP		
A1, A2	18, 19	PGNDL	Power Ground of the Linear TEC Controller.
N/A ¹	20	TMPGD	Temperature Good Output.
A3	21	OUT1	Output of the Error Amplifier.
A4	23	IN1P	Noninverting Input of the Error Amplifier.
A5	24	IN2P	Noninverting Input of the Compensation Amplifier.
B1, B2	17	LDR	Output of the Linear TEC Controller.
B3	22	IN1N	Inverting Input of the Error Amplifier.
B4	1	IN2N	Inverting Input of the Compensation Amplifier.
B5	3	VLIM/SD	Voltage Limit/Shutdown. This pin sets the cooling and heating TEC voltage limits. When this pin is pulled low, the device shuts down.
C1, C2	N/A ¹	PVIN	Power Input for the TEC Controller.
N/A ¹	16	PVINL	Power Input for the Linear TEC Driver.
N/A ¹	15	PVINS	Power Input for the PWM TEC Driver.
C3	11	ITEC	TEC Current Output.
C4	2	OUT2	Output of the Compensation Amplifier.
C5	4	ILIM	Current Limit. This pin sets the TEC cooling and heating current limits.
D1, D2	14	SW	Switch Node Output of the PWM TEC Controller.
D3	9	VTEC	TEC Voltage Output.
D4	8	EN/SY	Enable/Synchronization. Set this pin high to enable the device. An external synchronization clock input can be applied to this pin.
D5	5	VDD	Power for the Controller Circuits.
E1, E2	12, 13	PGNDS	Power Ground of the PWM TEC Controller.
E3	10	SFB	Feedback of the PWM TEC Controller Output.
E4	7	AGND	Signal Ground.
E5	6	VREF	2.5 V Reference Output.
N/A ¹	0	EPAD	Exposed Pad. Solder to the analog ground plane on the board.

¹ N/A means not applicable.

TYPICAL PERFORMANCE CHARACTERISTICS

$T_A = 25^\circ\text{C}$, unless otherwise noted.

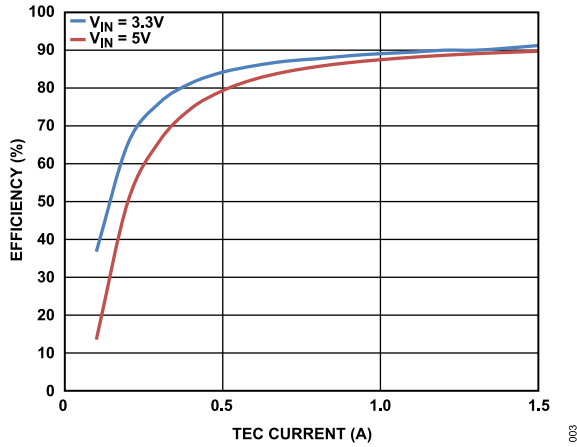

Figure 4. Efficiency vs. TEC Current at $V_{IN} = 3.3\text{ V}$ and 5 V in Cooling Mode with $2\ \Omega$ Load

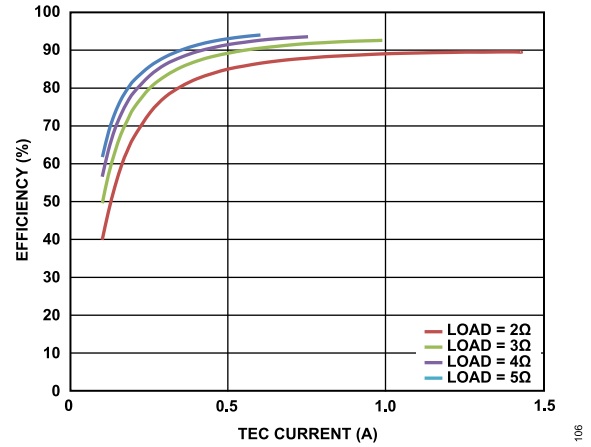

Figure 7. Efficiency vs. TEC Current at $V_{IN} = 3.3\text{ V}$ with Different Loads in Heating Mode

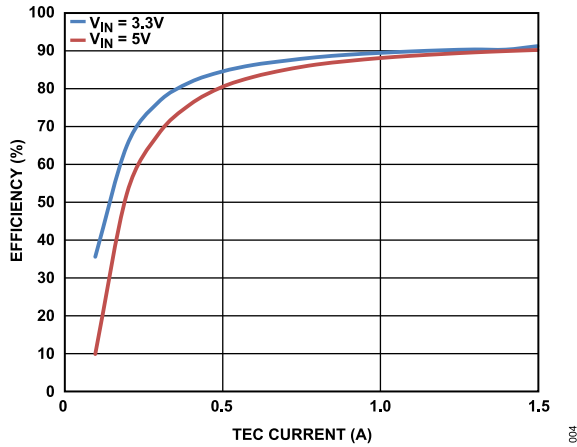

Figure 5. Efficiency vs. TEC Current at $V_{IN} = 3.3\text{ V}$ and 5 V in Heating Mode with $2\ \Omega$ Load

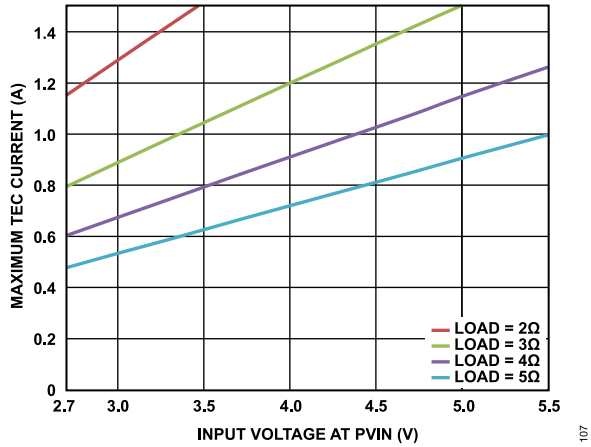

Figure 8. Maximum TEC Current vs. Input Voltage at PV_{IN} ($V_{IN} = 3.3\text{ V}$), Without Voltage and Current Limit in Cooling Mode

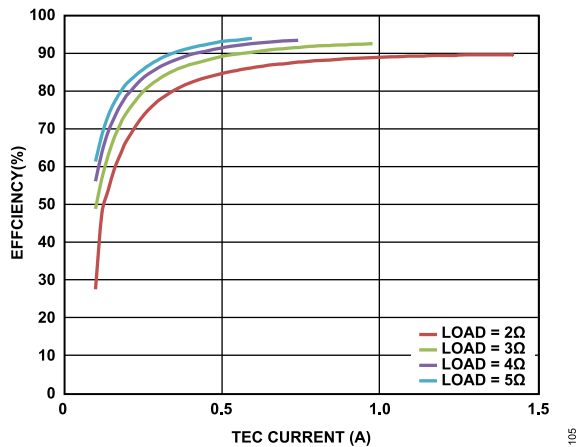

Figure 6. Efficiency vs. TEC Current at $V_{IN} = 3.3\text{ V}$ with Different Loads in Cooling Mode

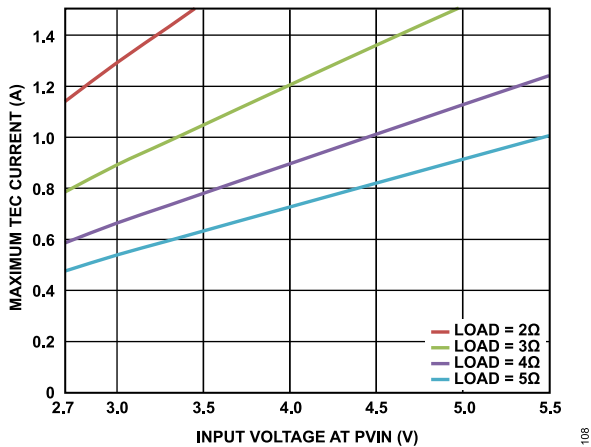

Figure 9. Maximum TEC Current vs. Input Voltage at PV_{IN} ($V_{IN} = 3.3\text{ V}$), Without Voltage and Current Limit in Heating Mode

TYPICAL PERFORMANCE CHARACTERISTICS

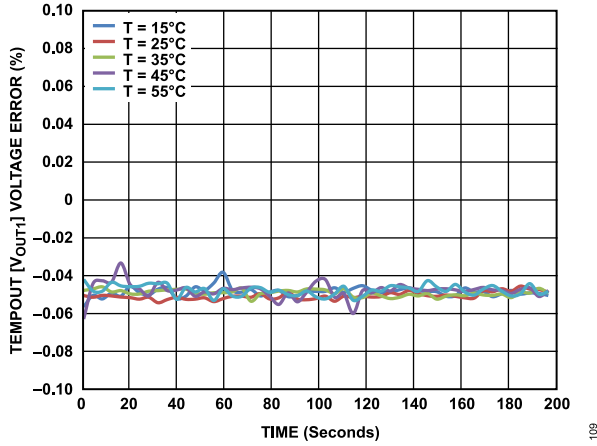

Figure 10. Thermal Stability over Ambient Temperature at $V_{IN} = 3.3\text{ V}$, $V_{TEMPSET} = 1\text{ V}$

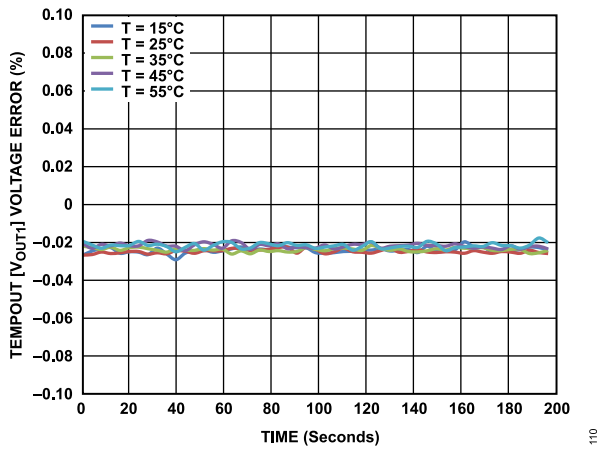

Figure 11. Thermal Stability over Ambient Temperature at $V_{IN} = 3.3\text{ V}$, $V_{TEMPSET} = 1.5\text{ V}$

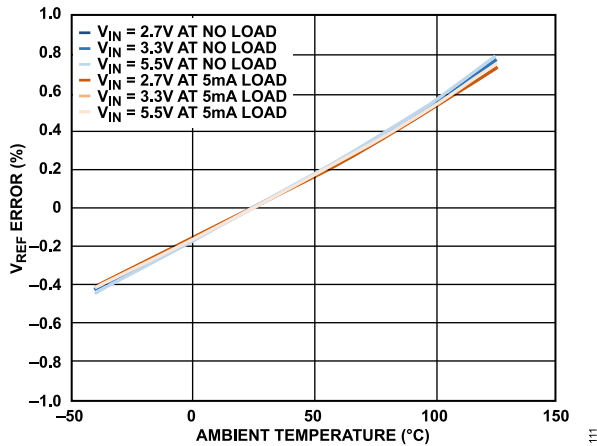

Figure 12. V_{REF} Error vs. Ambient Temperature

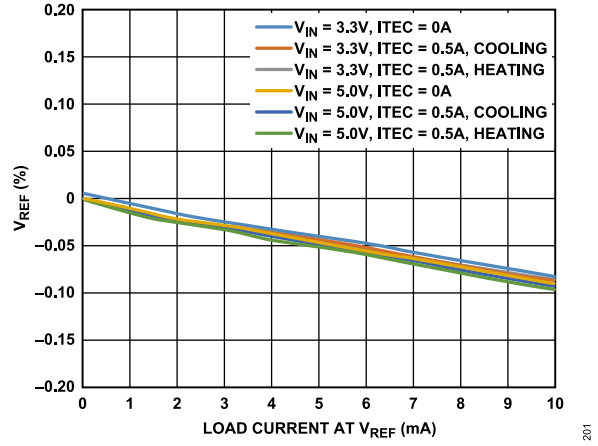

Figure 13. V_{REF} Load Regulation

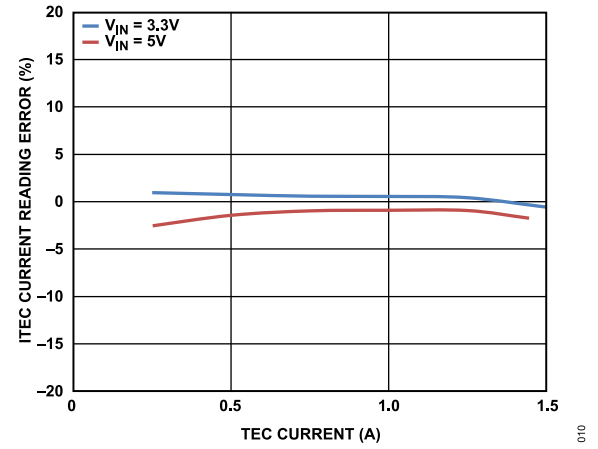

Figure 14. ITEC Current Reading Error vs. TEC Current in Cooling Mode

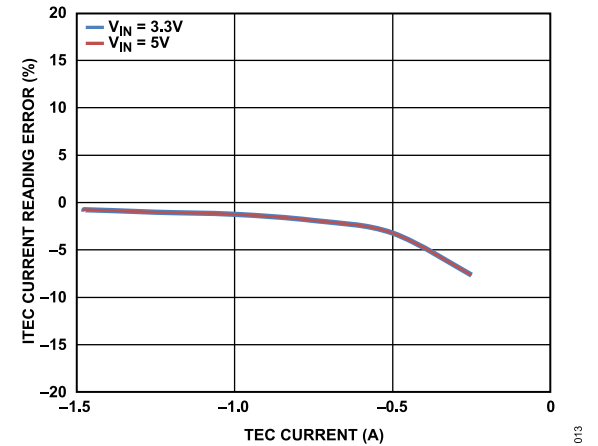

Figure 15. ITEC Current Reading Error vs. TEC Current in Heating Mode

TYPICAL PERFORMANCE CHARACTERISTICS

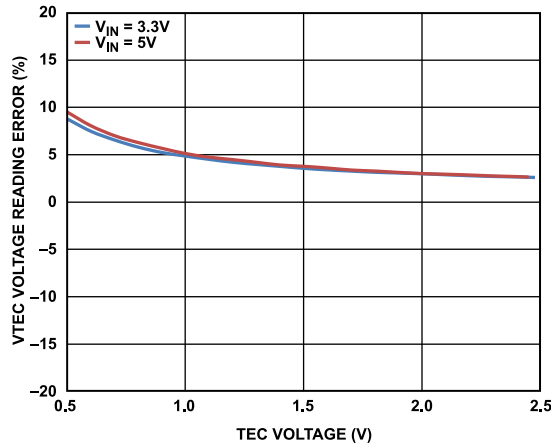

Figure 16. VTEC Voltage Reading Error vs. TEC Voltage in Cooling Mode

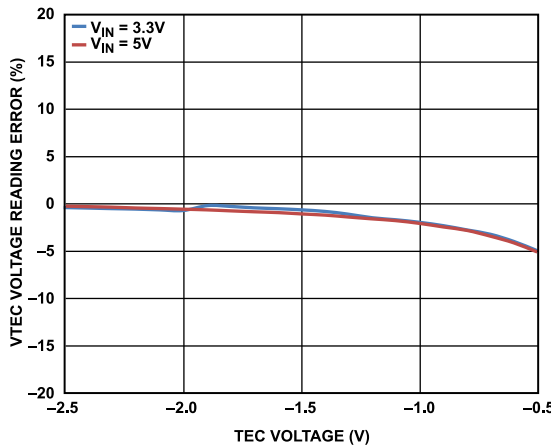

Figure 17. VTEC Voltage Reading Error vs. TEC Voltage in Heating Mode

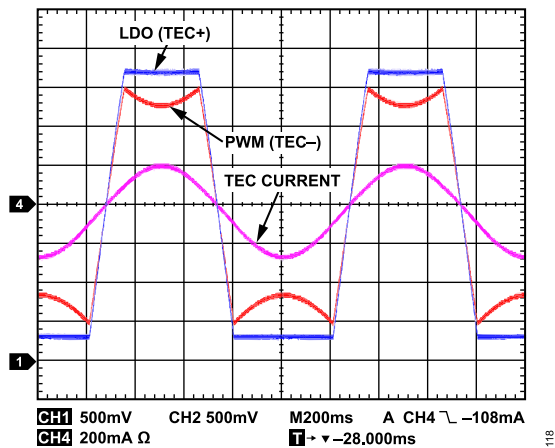

Figure 18. Cooling to Heating Transition

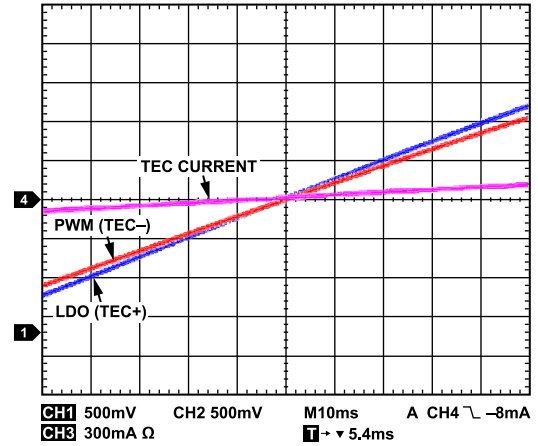

Figure 19. Zero-Crossing TEC Current Zoom in from Heating to Cooling

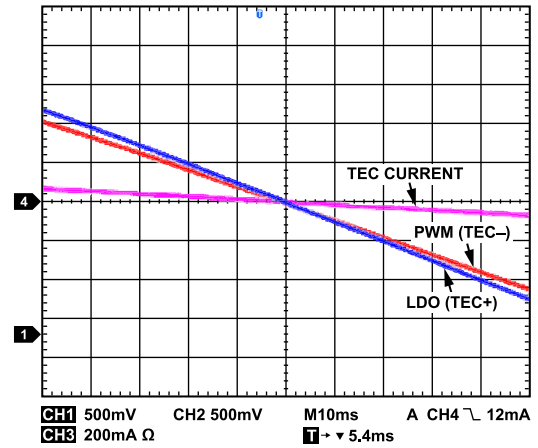

Figure 20. Zero-Crossing TEC Current Zoom in from Cooling to Heating

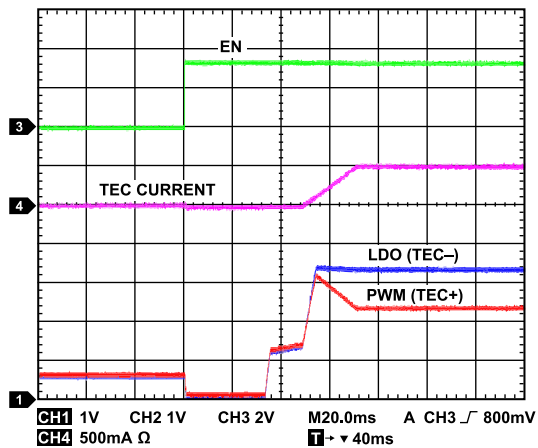

Figure 21. Typical Enable Waveforms in Cooling Mode, $V_{IN} = 3.3\text{ V}$, Load = 2 Ω , TEC Current = 1 A

TYPICAL PERFORMANCE CHARACTERISTICS

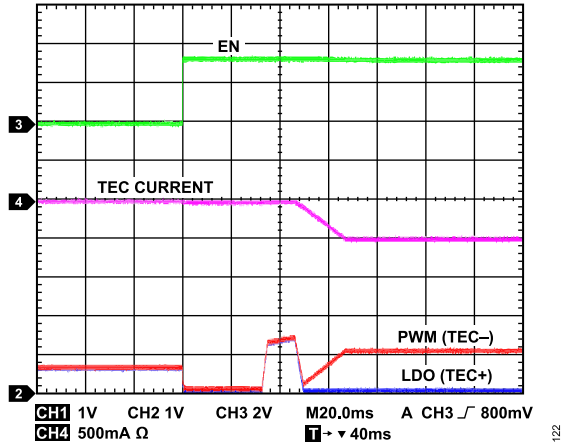

Figure 22. Typical Enable Waveforms in Heating Mode, $V_{IN} = 3.3\text{ V}$, Load = 2 Ω , TEC Current = 1 A

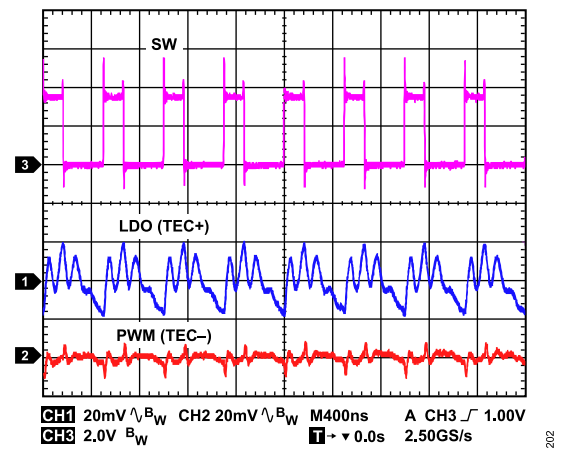

Figure 23. Typical Switch and Voltage Ripple Waveforms in Cooling Mode $V_{IN} = 3.3\text{ V}$, Load = 2 Ω , TEC Current = 1 A

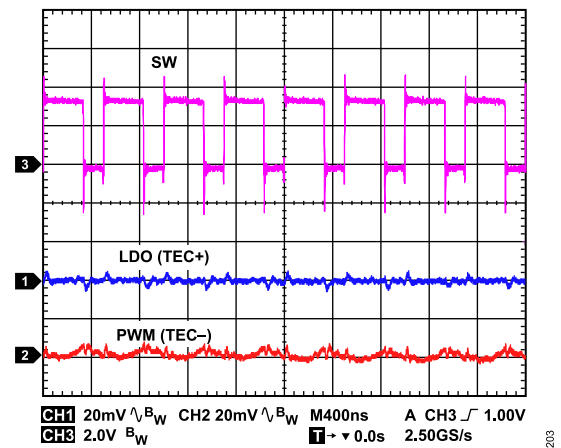

Figure 24. Typical Switch and Voltage Ripple Waveforms in Heating Mode, $V_{IN} = 3.3\text{ V}$, Load = 2 Ω , TEC Current = 1 A

DETAILED FUNCTIONAL BLOCK DIAGRAM

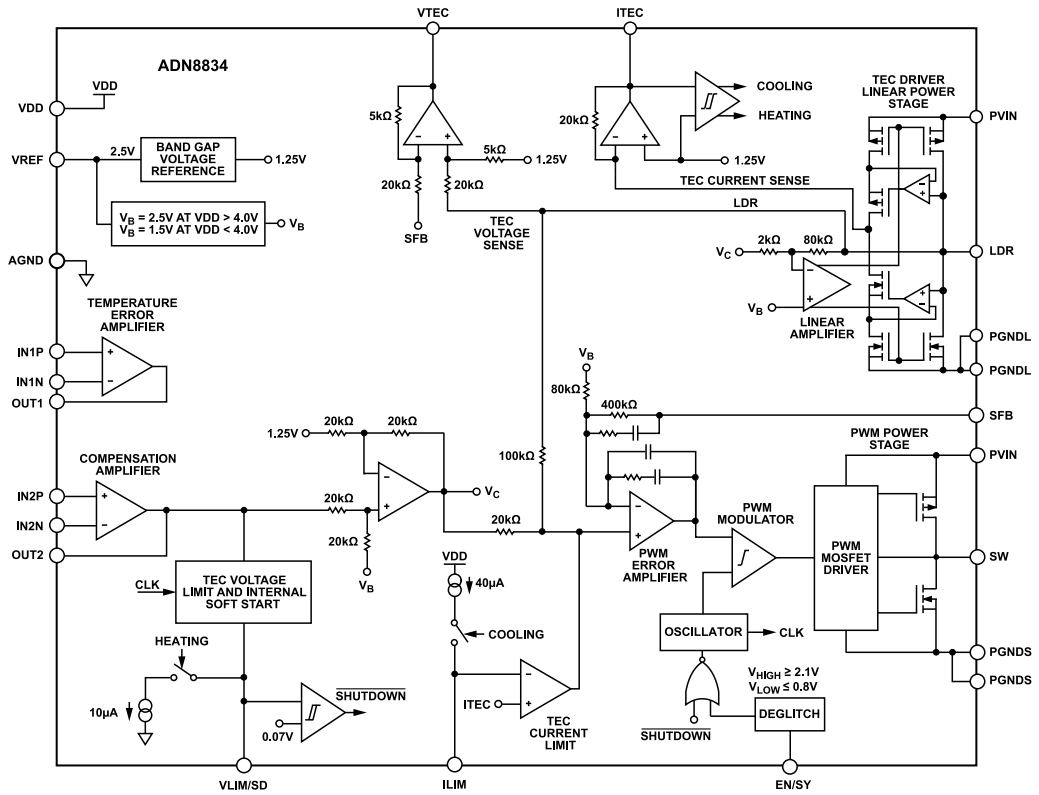

Figure 25. Detailed Functional Block Diagram of the ADN8834 for the WLCSF

THEORY OF OPERATION

The ADN8834 is a single chip TEC controller that sets and stabilizes a TEC temperature. A voltage applied to the input of the ADN8834 corresponds to the temperature setpoint of the target object attached to the TEC. The ADN8834 controls an internal FET H-bridge whereby the direction of the current fed through the TEC can be either positive (for cooling mode), to pump heat away from the object attached to the TEC, or negative (for heating mode), to pump heat into the object attached to the TEC.

Temperature is measured with a thermal sensor attached to the target object and the sensed temperature (voltage) is fed back to the ADN8834 to complete a closed thermal control loop of the TEC. For the best overall stability, couple the thermal sensor close to the TEC. In most laser diode modules, a TEC and an NTC thermistor are already mounted in the same package to regulate the laser diode temperature.

The TEC is differentially driven in an H-bridge configuration.

The ADN8834 drives its internal MOSFET transistors to provide the TEC current. To provide good power efficiency and zero-crossing quality, only one side of the H-bridge uses a PWM driver. Only one inductor and one capacitor are required to filter out the switching frequency. The other side of the H-bridge uses a linear output without requiring any additional circuitry. This proprietary configuration allows the ADN8834 to provide efficiency of >90%. For most applications, a 1 μH inductor, a 10 μF capacitor, and a switching frequency of 2 MHz maintain less than 1% of the worst-case output voltage ripple across a TEC.

The maximum voltage across the TEC and the current flowing through the TEC are set by using the VLIM/SD and ILIM pins. The maximum cooling and heating currents can be set independently to allow asymmetric heating and cooling limits. For additional details, see the [Maximum TEC Voltage Limit](#) section and the [Maximum TEC Current Limit](#) section.

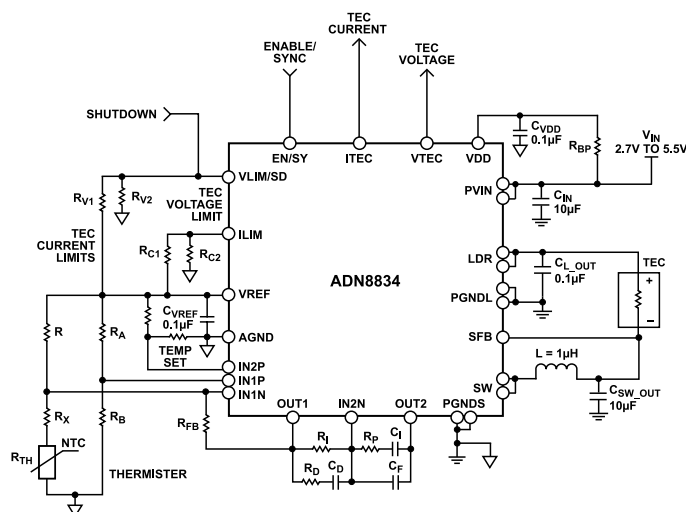

Figure 26. Typical Application Circuit with Analog PID Compensation in a Temperature Control Loop

THEORY OF OPERATION

ANALOG PID CONTROL

The ADN8834 integrates two self-correcting, auto-zeroing amplifiers (Chopper 1 and Chopper 2). The Chopper 1 amplifier takes a thermal sensor input and converts or regulates the input to a linear voltage output. The OUT1 voltage is proportional to the object temperature. The OUT1 voltage is fed into the compensation amplifier (Chopper 2) and is compared with a temperature setpoint voltage, which creates an error voltage that is proportional to the difference. For autonomous analog temperature control, Chopper 2 can be used to implement a PID network as shown in Figure 27 to set the overall stability and response of the thermal loop. Adjusting the PID network optimizes the step response of the TEC control loop. A compromised settling time and the maximum current ringing become available when this adjustment is done. To adjust the compensation network, see the PID Compensation Amplifier (Chopper 2) section.

DIGITAL PID CONTROL

The ADN8834 can also be configured for use in a software controlled PID loop. In this scenario, the Chopper 1 amplifier can either be left unused or configured as a thermistor input amplifier connected to an external temperature measurement analog-to-digital converter (ADC). For more information, see the Thermistor Amplifier (Chopper 1) section. If Chopper 1 is left unused, tie IN1N and IN1P to AGND.

The Chopper 2 amplifier is used as a buffer for the external DAC, which controls the temperature setpoint. Connect the DAC to IN2P

and short the IN2N and OUT2 pins together. See Figure 27 for an overview of how to configure the ADN8834 external circuitry for digital PID control.

POWERING THE CONTROLLER

The ADN8834 operates at an input voltage range of 2.7 V to 5.5 V that is applied to the VDD pin and the PVIN pin for the WLCSP (the PVINS pin and PVINL pin for the LFCSP). The VDD pin is the input power for the driver and internal reference. The PVIN input power pins are combined for both the linear and the switching driver. Apply the same input voltage to all power input pins: VDD and PVIN. In some circumstances, an RC low-pass filter can be added optionally between the PVIN for the WLCSP (PVINS and PVINL for the LFCSP) and VDD pins to prevent high frequency noise from entering VDD, as shown in Figure 27. The capacitor and resistor values are typically 10 Ω and 100 nF, respectively.

When configuring power supply to the ADN8834, keep in mind that at high current loads, the input voltage may drop substantially due to a voltage drop on the wires between the front-end power supply and the PVIN pin for the WLCSP (PVINS and PVINL for the LFCSP). Leave a proper voltage margin when designing the front-end power supply to maintain the performance. Minimize the trace length from the power supply to the PVIN pin for the WLCSP (PVINS and PVINL for the LFCSP) to help mitigate the voltage drop.

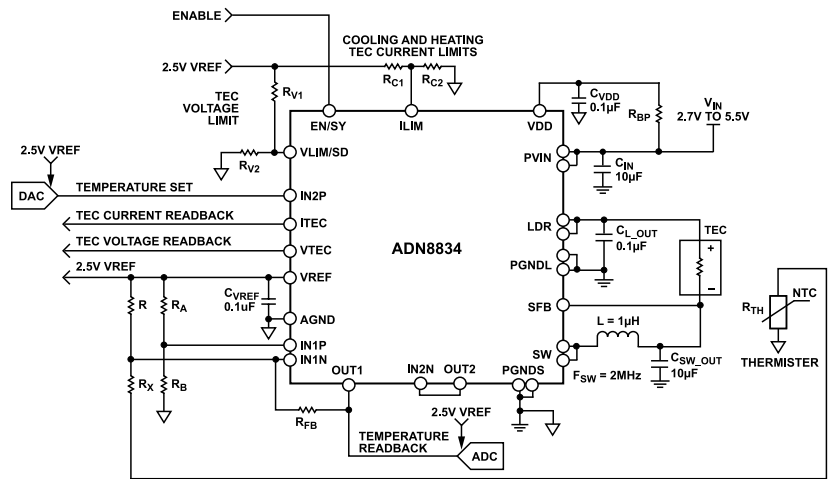

Figure 27. TEC Controller in a Digital Temperature Control Loop (WLCSP)

THEORY OF OPERATION

ENABLE AND SHUTDOWN

To enable the ADN8834, apply a logic high voltage to the EN/SY pin while the voltage at the VLIM/SD pin is above the maximum shutdown threshold of 0.07 V. If either the EN/SY pin voltage is set to logic low or the VLIM/SD voltage is below 0.07 V, the controller goes into an ultralow current state. The current drawn in shutdown mode is 350 μ A typically. Most of the current is consumed by the VREF circuit block, which is always on even when the device is disabled or shut down. The device can also be enabled when an external synchronization clock signal is applied to the EN/SY pin, and the voltage at VLIM/SD input is above 0.07 V. Table 6 shows the combinations of the two input signals that are required to enable the ADN8834.

Table 6. Enable Pin Combinations

EN/SY Input	VLIM/SD Input	Controller
>2.1 V	>0.07 V	Enabled
Switching between high >2.1 V and low <0.8 V	>0.07 V	Enabled
<0.8 V	No effect ¹	Shutdown
Floating	No effect ¹	Shutdown
No effect ¹	≤ 0.07 V	Shutdown

¹ No effect means this signal has no effect in shutting down or in enabling the device.

OSCILLATOR CLOCK FREQUENCY

The ADN8834 has an internal oscillator that generates a 2.0 MHz switching frequency for the PWM output stage. This oscillator is active when the enabled voltage at the EN/SY pin is set to a logic level higher than 2.1 V and the VLIM/SD pin voltage is greater than the shutdown threshold of 0.07 V.

External Clock Operation

The PWM switching frequency of the ADN8834 can be synchronized to an external clock from 1.85 MHz to 3.25 MHz, applied to the EN/SY input pin as shown on Figure 28.

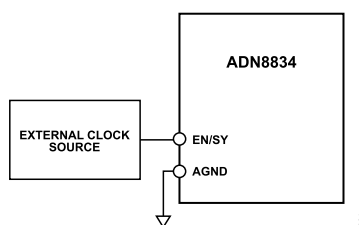

Figure 28. Synchronize to an External Clock

Connecting Multiple ADN8834 Devices

Multiple ADN8834 devices can be driven from a single master clock signal by connecting the external clock source to the EN/SY pin of each slave device. The input ripple can be greatly reduced by operating the ADN8834 devices 180° out of phase from each other

by placing an inverter at one of the EN/SY pins, as shown in Figure 29.

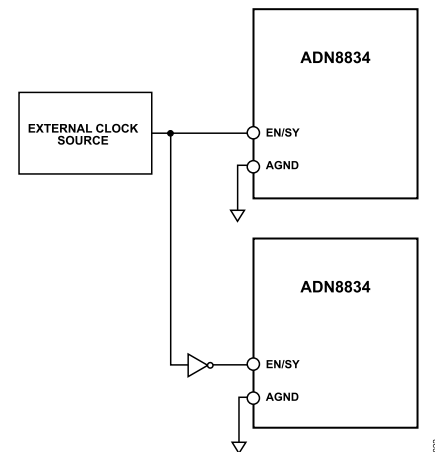

Figure 29. Multiple ADN8834 Devices Driven from a Master Clock

TEMPERATURE LOCK INDICATOR (LFCSP ONLY)

The TMPGD outputs logic high when the temperature error amplifier output voltage, V_{OUT1} , reaches the IN2P temperature setpoint (TEMPSET) voltage. The TMPGD has a detection range between 1.46 V and 1.54 V of V_{OUT1} and hysteresis. The TMPGD function allows direct interfacing either to the microcontrollers or to the supervisory circuitry.

SOFT START ON POWER-UP

The ADN8834 has an internal soft start circuit that generates a ramp with a typical 150 ms profile to minimize inrush current during power-up. The settling time and the final voltage across the TEC depends on the TEC voltage required by the control voltage of voltage loop. The higher the TEC voltage is, the longer it requires to be built up.

When the ADN8834 is first powered up, the linear side discharges the output of any prebias voltage. As soon as the prebias is eliminated, the soft start cycle begins. During the soft start cycle, both the PWM and linear outputs track the internal soft start ramp until they reach midscale, where the control voltage, V_C , is equal to the bias voltage, V_B . From the midscale voltage, the PWM and linear outputs are then controlled by V_C and diverge from each other until the required differential voltage is developed across the TEC or the differential voltage reaches the voltage limit. The voltage developed across the TEC depends on the control point at that moment in time. Figure 30 shows an example of the soft start in cooling mode. Note that, as both the LDR and SFB voltages increase with the soft start ramp and approach V_B , the ramp slows down to avoid possible current overshoot at the point where the TEC voltage starts to build up.

THEORY OF OPERATION

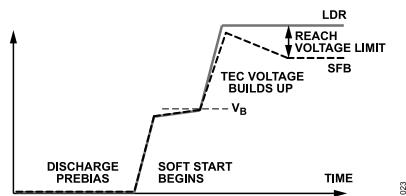

Figure 30. Soft Start Profile in Cooling Mode

TEC VOLTAGE/CURRENT MONITOR

The TEC real-time voltage and current are detectable at VTEC and ITEC, respectively.

Voltage Monitor

VTEC is an analog voltage output pin with a voltage proportional to the actual voltage across the TEC. A center VTEC voltage of 1.25 V corresponds to 0 V across the TEC. Convert the voltage at VTEC and the voltage across the TEC using the following equation:

$$V_{VTEC} = 1.25 \text{ V} + 0.25 \times (V_{LDR} - V_{SFB})$$

Current Monitor

ITEC is an analog voltage output pin with a voltage proportional to the actual current through the TEC. A center ITEC voltage of 1.25 V corresponds to 0 A through the TEC. Convert the voltage at ITEC and the current through the TEC using the following equations:

$$V_{ITEC_COOLING} = 1.25 \text{ V} + I_{LDR} \times R_{CS}$$

where the current sense gain (R_{CS}) is 0.525 V/A.

$$V_{ITEC_HEATING} = 1.25 \text{ V} - I_{LDR} \times R_{CS}$$

MAXIMUM TEC VOLTAGE LIMIT

The maximum TEC voltage is set by applying a voltage divider at the VLIM/SD pin to protect the TEC. The voltage limiter operates bidirectionally and allows the cooling limit to be different from the heating limit.

Using a Resistor Divider to Set the TEC Voltage Limit

Separate voltage limits are set using a resistor divider. The internal current sink circuitry connected to VLIM/SD draws a current when the ADN8834 drives the TEC in a heating direction, which lowers the voltage at VLIM/SD. The current sink is not active when the TEC is driven in a cooling direction; therefore, the TEC heating voltage limit is always lower than the cooling voltage limit.

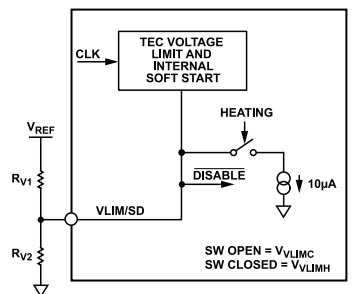

Figure 31. Using a Resistor Divider to Set the TEC Voltage Limit

Calculate the cooling and heating limits using the following equations:

$$V_{VLIM_COOLING} = V_{REF} \times R_{V2} / (R_{V1} + R_{V2})$$

where $V_{REF} = 2.5 \text{ V}$.

$$V_{VLIM_HEATING} = V_{VLIM_COOLING} - I_{SINK_VLIM} \times R_{V1} \parallel R_{V2}$$

where $I_{SINK_VLIM} = 10 \mu\text{A}$.

$$V_{TEC_MAX_COOLING} = V_{VLIM_COOLING} \times A_{VLIM}$$

where $A_{VLIM} = 2 \text{ V/V}$.

$$V_{TEC_MAX_HEATING} = V_{VLIM_HEATING} \times A_{VLIM}$$

MAXIMUM TEC CURRENT LIMIT

To protect the TEC, separate maximum TEC current limits in cooling and heating directions are set by applying a voltage combination at the ILIM pin.

Using a Resistor Divider to Set the TEC Current Limit

The internal current sink circuitry connected to ILIM draws a 40 μA current when the ADN8834 drives the TEC in a cooling direction, which allows a high cooling current. Use the following equations to calculate the maximum TEC currents:

$$V_{ILIM_HEATING} = V_{REF} \times R_{C2} / (R_{C1} + R_{C2})$$

where $V_{REF} = 2.5 \text{ V}$.

$$V_{ILIM_COOLING} = V_{ILIM_HEATING} + I_{SINK_ILIM} \times R_{C1} \parallel R_{C2}$$

where $I_{SINK_ILIM} = 40 \mu\text{A}$.

$$I_{TEC_MAX_COOLING} = \frac{V_{ILIM_COOLING} - 1.25 \text{ V}}{R_{CS}}$$

where $R_{CS} = 0.525 \text{ V/A}$.

$$I_{TEC_MAX_HEATING} = \frac{1.25 \text{ V} - V_{ILIM_HEATING}}{R_{CS}}$$

$V_{ILIM_HEATING}$ must not exceed 1.2 V and $V_{ILIM_COOLING}$ must be more than 1.3 V to leave proper margins between the heating and the cooling modes.

THEORY OF OPERATION

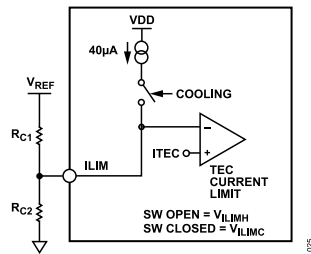

Figure 32. Using a Resistor Divider to Set the TEC Current Limit

APPLICATIONS INFORMATION

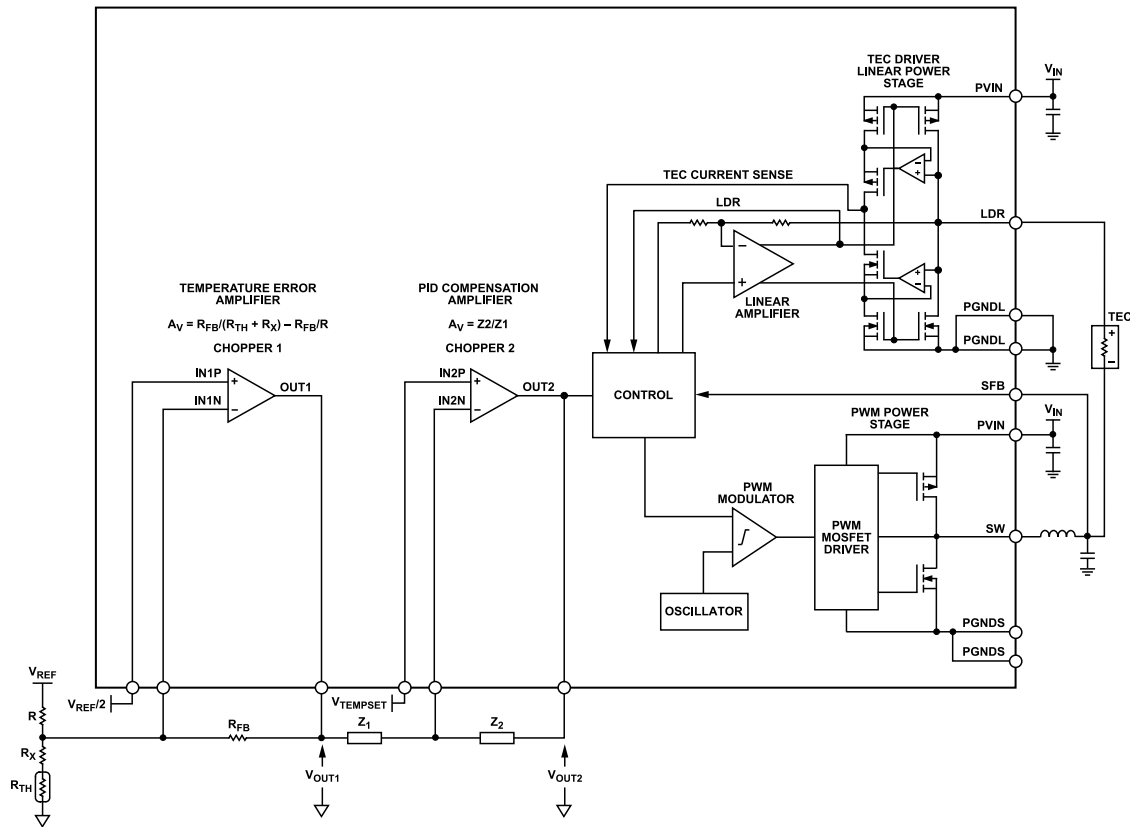

Figure 33. Signal Flow Block Diagram

SIGNAL FLOW

The ADN8834 integrates two auto-zero amplifiers, defined as the Chopper 1 amplifier and the Chopper 2 amplifier. Both of the amplifiers can be used as standalone amplifiers; therefore, the implementation of temperature control can vary. Figure 33 shows the signal flow through the ADN8834, and a typical implementation of the temperature control loop using the Chopper 1 amplifier and the Chopper 2 amplifier.

In Figure 33, the Chopper 1 and Chopper 2 amplifiers are configured as the thermistor input amplifier and the PID compensation amplifier, respectively. The thermistor input amplifier gains the thermistor voltage, then outputs to the PID compensation amplifier. The PID compensation amplifier then compensates a loop response over the frequency domain.

The output from the compensation loop at OUT2 is fed to the linear MOSFET gate driver. The voltage at LDR is fed with OUT2 into the PWM MOSFET gate driver. Including the internal transistors, the gain of the differential output section is fixed at 5. For details on the output drivers, see the [MOSFET Driver Amplifiers](#) section.

THERMISTOR SETUP

The thermistor has a nonlinear relationship to temperature; near optimal linearity over a specified temperature range can be achieved with the proper value of R_X placed in series with the thermistor.

First, the resistance of the thermistor must be known, where

- ▶ $R_{LOW} = R_{TH}$ at T_{LOW}
- ▶ $R_{MID} = R_{TH}$ at T_{MID}
- ▶ $R_{HIGH} = R_{TH}$ at T_{HIGH}

T_{LOW} and T_{HIGH} are the endpoints of the temperature range and T_{MID} is the average. In some cases, with only the β constant available, calculate R_{TH} using the following equation:

$$R_{TH} = R_R \exp\left\{\beta\left(\frac{1}{T} - \frac{1}{T_R}\right)\right\}$$

where:

R_{TH} is a resistance at T (K).
 R_R is a resistance at T_R (K).

Calculate R_X using the following equation:

$$R_X = \left(\frac{R_{LOW}R_{MID} + R_{MID}R_{HIGH} - 2R_{LOW}R_{HIGH}}{R_{LOW} + R_{HIGH} - 2R_{MID}}\right)$$

THERMISTOR AMPLIFIER (CHOPPER 1)

The Chopper 1 amplifier can be used as a thermistor input amplifier. In Figure 33, the output voltage is a function of the thermistor temperature. The voltage at OUT1 is expressed as:

$$V_{OUT1} = \left(\frac{R_{FB}}{R_{TH} + R_X} - \frac{R_{FB}}{R} + 1\right) \times \frac{V_{REF}}{2} \quad (1)$$

APPLICATIONS INFORMATION

where:

R_{TH} is a thermistor.

R_X is a compensation resistor.

Calculate R using the following equation:

$$R = R_X + R_{TH_@_25^\circ C}$$

V_{OUT1} is centered around $V_{REF}/2$ at 25°C. An average temperature-to-voltage coefficient is $-25 \text{ mV}/^\circ\text{C}$ at a range of 5°C to 45°C.

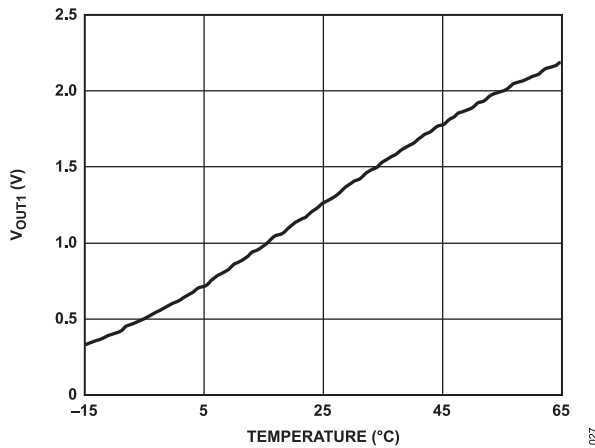

Figure 34. V_{OUT1} vs. Temperature

PID COMPENSATION AMPLIFIER (CHOPPER 2)

Use the Chopper 2 amplifier as the PID compensation amplifier. The voltage at OUT1 feeds into the PID compensation amplifier. The frequency response of the PID compensation amplifier is dictated by the compensation network. Apply the temperature set voltage at IN2P. In Figure 39, the voltage at OUT2 is calculated using the following equation:

$$V_{OUT2} = V_{TEMPSET} - \frac{Z2}{Z1}(V_{OUT1} - V_{TEMPSET})$$

where:

$V_{TEMPSET}$ is the control voltage input to the IN2P pin.

Z1 is the combination of R_i , R_D , and C_D (see Figure 35).

Z2 is the combination of R_p , C_i , and C_F (see Figure 35).

The user sets the exact compensation network. This network varies from a simple integrator to proportional-integral (PI), PID (proportional-integral-derivative), or any other type of network. The user also determines the type of compensation and component values because they are dependent on the thermal response of the object and the TEC. One method to empirically determine these values is to input a step function to IN2P; thus changing the target temperature, and adjust the compensation network to minimize the settling time of the TEC temperature.

A typical compensation network for temperature control of a laser module is a PID loop consisting of a very low frequency pole and two separate zeros at higher frequencies. Figure 35 shows a simple network for implementing PID compensation. To reduce the noise

sensitivity of the control loop, an additional pole is added at a higher frequency than that of the zeros. The bode plot of the magnitude is shown in Figure 36. Use the following equation to calculate the unity-gain crossover frequency of the feed-forward amplifier:

$$f_{odB} = \frac{1}{2\pi R_i C_i} \times \left(\frac{R_{FB}}{R_{TH} + R_X} - \frac{R_{FB}}{R} \right) \times TECGAIN$$

To ensure stability, the unity-gain crossover frequency must be lower than the thermal time constant of the TEC and thermistor. However, this thermal time constant is sometimes unspecified, making it difficult to characterize. There are many texts written on loop stabilization, and it is beyond the scope of this data sheet to discuss all methods and trade-offs for optimizing compensation networks.

V_{OUT1} is a convenient measure to gauge the thermal instability of the system, which is also known as TEMPOUT. If the thermal loop is in steady state, the TEMPOUT voltage equals the TEMPSET voltage, meaning that the temperature of the controlled object equals the target temperature.

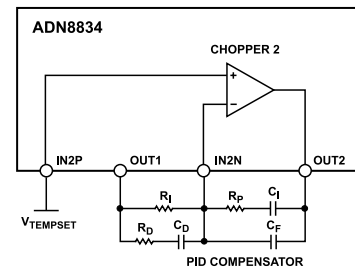

Figure 35. Implementing a PID Compensation Loop

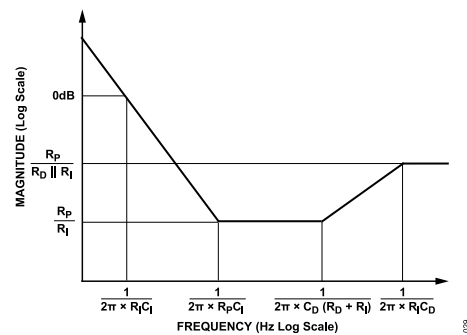

Figure 36. Bode Plot for PID Compensation

MOSFET DRIVER AMPLIFIERS

The ADN8834 has two separate MOSFET drivers: a switched output or pulse-width modulated (PWM) amplifier, and a high gain linear amplifier. Each amplifier has a pair of outputs that drive the gates of the internal MOSFETs, which, in turn, drive the TEC as shown in Figure 33. A voltage across the TEC is monitored via the SFB and LDR pins. Although both MOSFET drivers achieve the same result, to provide constant voltage and high current, their operation is different. The exact equations for the two outputs are

APPLICATIONS INFORMATION

$$V_{LDR} = V_B - 40(V_{OUT2} - 1.25 \text{ V})$$

$$V_{SFB} = V_{LDR} + 5(V_{OUT2} - 1.25 \text{ V})$$

where:

V_{OUT2} is the voltage at OUT2.

V_B is determined by V_{VDD} as

$$V_B = 1.5 \text{ V for } V_{VDD} < 4.0 \text{ V}$$

$$V_B = 2.5 \text{ V for } V_{VDD} > 4.0 \text{ V}$$

The compensation network that receives the temperature set voltage and the thermistor voltage fed by the input amplifier determines the voltage at OUT2. V_{LDR} and V_{SFB} have a low limit of 0 V and an upper limit of V_{VDD} . Figure 37, Figure 38, and Figure 39 show the graphs of these equations.

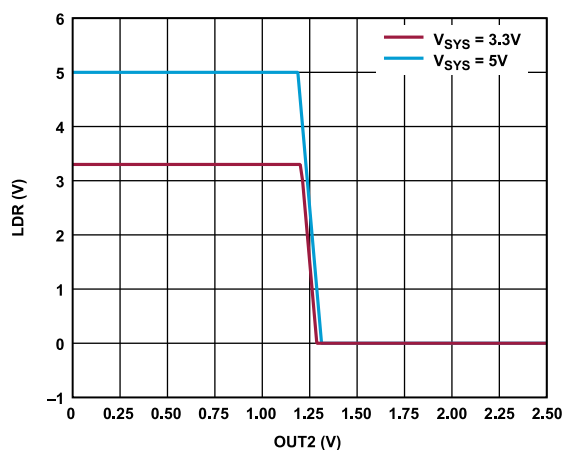

Figure 37. LDR Voltage vs. OUT2 Voltage

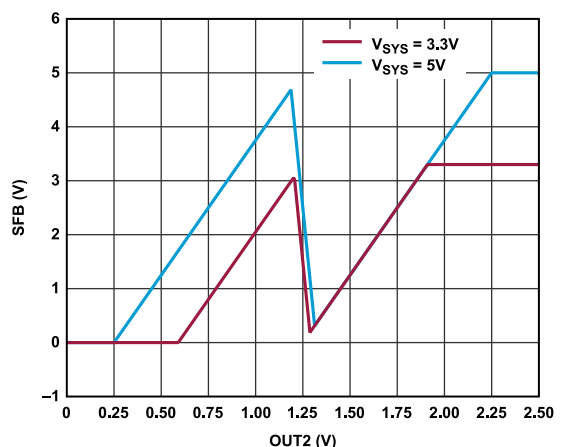

Figure 38. SFB Voltage vs. OUT2 Voltage

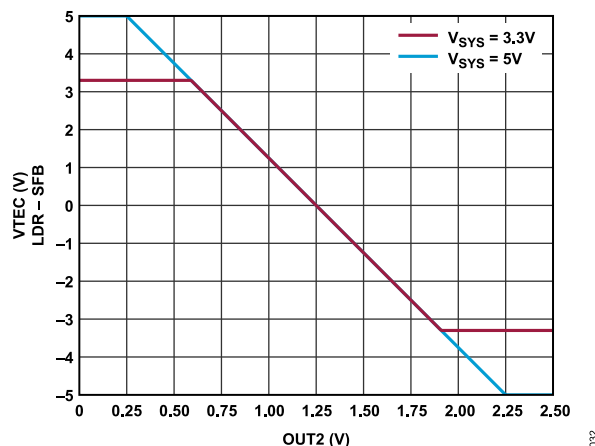

Figure 39. TEC Voltage vs. OUT2 Voltage

PWM OUTPUT FILTER REQUIREMENTS

A Type 3 compensator internally compensates the PWM amplifier. Because the poles and zeros of the compensator are designed and fixed by assuming the resonance frequency of the output LC tank is 50 kHz, the selection of the inductor and the capacitor must follow this guideline to ensure system stability.

Inductor Selection

The inductor selection determines the inductor current ripple and loop dynamic response. Larger inductance results in smaller current ripple and slower transient response as smaller inductance results in the opposite performance. To optimize the performance, the trade-off must be made between transient response speed, efficiency, and component size. Calculate the inductor value with the following equation:

$$L = \frac{V_{SW_OUT} \times (V_{IN} - V_{SW_OUT})}{V_{IN} \times f_{SW} \times \Delta I_L}$$

where:

V_{SW_OUT} is the PWM amplifier output.

f_{SW} is the switching frequency (2 MHz by default).

ΔI_L is the inductor current ripple.

A 1 μH inductor is typically recommended to allow reasonable output capacitor selection while maintaining a low inductor current ripple. If lower inductance is required, a minimum inductor value of 0.68 μH is suggested to ensure that the current ripple is set to a value between 30% and 40% of the maximum load current, which is 1.5 A.

Except for the inductor value, the equivalent dc resistance (DCR) inherent in the metal conductor is also a critical factor for inductor selection. The DCR accounts for most of the power loss on the inductor by $\text{DCR} \times I_{OUT}^2$. Using an inductor with high DCR degrades the overall efficiency significantly. In addition, there is a conduct voltage drop across the inductor because of the DCR. When the PWM amplifier is sinking current in cooling mode, this voltage

APPLICATIONS INFORMATION

drives the minimum voltage of the amplifier higher than $0.06 \times V_{IN}$ by at least tenth of millivolts. Similarly, the maximum PWM amplifier output voltage is lower than $0.93 \times V_{IN}$.

This voltage drop is proportional to the value of the DCR and it reduces the output voltage range at the TEC.

When selecting an inductor, ensure that the saturation current rating is higher than the maximum current peak to prevent saturation. In general, ceramic multilayer inductors are suitable for low current applications due to small size and low DCR. When the noise level is critical, use a shielded ferrite inductor to reduce the electromagnetic interference (EMI).

Table 7. Recommended Inductors

Vendor	Value	Device No.	Footprint
Toko	1.0 μ H \pm 20%, 2.6 A (typical)	DFE201612R-H-1R0M	2.0 \times 1.6
Taiyo Yuden	1.0 μ H \pm 20%, 2.2 A (typical)	MAKK2016T1R0M	2.0 \times 1.6
Murata	1.0 μ H \pm 20%, 2.3 A (typical)	LQM2MPN1R0MGH	2.0 \times 1.6

Capacitor Selection

The output capacitor selection determines the output voltage ripple, transient response, as well as the loop dynamic response of the PWM amplifier output. Use the following equation to select the capacitor:

$$C = \frac{V_{SW_OUT} \times (V_{IN} - V_{SW_OUT})}{V_{IN} \times 8 \times L \times (f_{SW})^2 \times \Delta V_{OUT}}$$

Note that the voltage caused by the product of current ripple, ΔI_L , and the capacitor equivalent series resistance (ESR) also add up to the total output voltage ripple. Selecting a capacitor with low ESR can increase overall regulation and efficiency performance.

Table 8. Recommended Capacitors

Vendor	Value	Device No.	Footprint (mm)
Murata	10 μ F \pm 10%, 10 V	ZRB18AD71A106KE01L	1.6 \times 0.8
Murata	10 μ F \pm 20%, 10 V	GRM188D71A106MA73	1.6 \times 0.8
Taiyo Yuden	10 μ F \pm 20%, 10 V	LMK107BC6106MA-T	1.6 \times 0.8

INPUT CAPACITOR SELECTION

On the PVIN pin, the amplifiers require an input capacitor to decouple the noise and to provide the transient current to maintain a stable input and output voltage. A 10 μ F ceramic capacitor rated at 10 V is the minimum recommended value. Increasing the capacitance reduces the switching ripple that couples into the power supply but increases the capacitor size. Because the current at the input terminal of the PWM amplifier is discontinuous, a capacitor

with low effective series inductance (ESL) is preferred to reduce voltage spikes.

In most applications, a decoupling capacitor is used in parallel with the input capacitor. The decoupling capacitor is usually a 100 nF ceramic capacitor with very low ESR and ESL, which provides better noise rejection at high frequency bands.

POWER DISSIPATION

This section provides guidelines to calculate the power dissipation of the ADN8834. Approximate the total power dissipation in the device by

$$P_{LOSS} = P_{PWM} + P_{LINEAR}$$

where:

P_{LOSS} is the total power dissipation in the ADN8834.

P_{LINEAR} is the power dissipation in the linear regulator.

PWM Regulator Power Dissipation

The PWM power stage is configured as a buck regulator and its dominant power dissipation (P_{PWM}) includes power switch conduction losses (P_{COND}), switching losses (P_{SW}), and transition losses (P_{TRAN}). Other sources of power dissipation are usually less significant at the high output currents of the application thermal limit and can be neglected in approximation.

Use the following equation to estimate the power dissipation of the buck regulator:

$$P_{LOSS} = P_{COND} + P_{SW} + P_{TRAN}$$

Conduction Loss (P_{COND})

The conduction loss consists of two parts: inductor conduction loss (P_{COND_L}) and power switch conduction loss (P_{COND_S}).

$$P_{COND} = P_{COND_L} + P_{COND_S}$$

Inductor conduction loss is proportional to the DCR of the output inductor, L. Using an inductor with low DCR enhances the overall efficiency performance. Estimate inductor conduction loss by

$$P_{COND_L} = DCR \times I_{OUT}^2$$

Power switch conduction losses are caused by the flow of the output current through both the high-side and low-side power switches, each of which has its own internal on resistance ($R_{DS(on)}$).

Use the following equation to estimate the amount of power switch conduction loss:

$$P_{COND_S} = (R_{DS(on)_HS} \times D + R_{DS(on)_LS} \times (1 - D)) \times I_{OUT}^2$$

where:

$R_{DS(on)_HS}$ is the on resistance of the high-side MOSFET.

D is the duty cycle ($D = V_{OUT}/V_{IN}$).

$R_{DS(on)_LS}$ is the on resistance of the low-side MOSFET.

APPLICATIONS INFORMATION

Switching Loss (P_{SW})

Switching losses are associated with the current drawn by the controller to turn the power devices on and off at the switching frequency. Each time a power device gate is turned on or off, the controller transfers a charge from the input supply to the gate, and then from the gate to ground. Use the following equation to estimate the switching loss:

$$P_{SW} = (C_{GATE_HS} + C_{GATE_LS}) \times V_{IN}^2 \times f_{SW}$$

where:

C_{GATE_HS} is the gate capacitance of the high-side MOSFET.

C_{GATE_LS} is the gate capacitance of the low-side MOSFET.

f_{SW} is the switching frequency.

For the ADN8834, the total of ($C_{GATE_HS} + C_{GATE_LS}$) is approximately 1 nF.

Transition Loss (P_{TRAN})

Transition losses occur because the high-side MOSFET cannot turn on or off instantaneously. During a switch node transition, the MOSFET provides all the inductor current. The source-to-drain voltage of the MOSFET is half the input voltage, resulting in power loss. Transition losses increase with both load and input voltage and occur twice for each switching cycle.

Use the following equation to estimate the transition loss:

$$P_{TRAN} = 0.5 \times V_{IN} \times I_{OUT} \times (t_R + t_F) \times f_{SW}$$

where:

t_R is the rise time of the switch node.

t_F is the fall time of the switch node.

For the ADN8834, t_R and t_F are both approximately 1 ns.

Linear Regulator Power Dissipation

The power dissipation of the linear regulator is given by the following equation:

$$P_{LINEAR} = [(V_{IN} - V_{OUT}) \times I_{OUT}] + (V_{IN} \times I_{GND})$$

where:

V_{IN} and V_{OUT} are the input and output voltages of the linear regulator.

I_{OUT} is the load current of the linear regulator.

I_{GND} is the ground current of the linear regulator.

Power dissipation due to the ground current is generally small and can be ignored for the purposes of this calculation.

PCB LAYOUT GUIDELINES

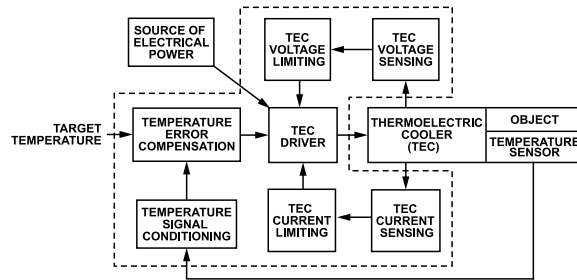

Figure 40. System Block Diagram

BLOCK DIAGRAMS AND SIGNAL FLOW

The ADN8834 integrates analog signal conditioning blocks, a load protection block, and a TEC controller power stage all in a single IC. To achieve the best possible circuit performance, attention must be paid to keep noise of the power stage from contaminating the sensitive analog conditioning and protection circuits. In addition, the layout of the power stage must be performed such that the IR losses are minimized to obtain the best possible electrical efficiency.

The system block diagram of the ADN8834 is shown in Figure 40.

GUIDELINES FOR REDUCING NOISE AND MINIMIZING POWER LOSS

Each printed circuit board (PCB) layout is unique because of the physical constraints defined by the mechanical aspects of a given design. In addition, several other circuits work in conjunction with the TEC controller; these circuits have their own layout requirements, so there are always compromises that must be made for a given system. However, to minimize noise and keep power losses to a minimum during the PCB layout process, observe the following guidelines.

General PCB Layout Guidelines

Switching noise can interfere with other signals in the system; therefore, the switching signal traces must be placed away from the power stage to minimize the effect. If possible, place the ground plate between the small signal layer and power stage layer as a shield.

Supply voltage drop on traces is also an important consideration because it determines the voltage headroom of the TEC controller at high currents. For example, if the supply voltage from the front-end system is 3.3 V, and the voltage drop on the traces is 0.5 V, PVIN sees only 2.8 V, which limits the maximum voltage of the linear regulator as well as the maximum voltage across the TEC. To mitigate the voltage waste on traces and impedance interconnection, place the ADN8834 and the input decoupling components close to the supply voltage terminal. This placement not only improves the system efficiency but also provides better regulation performance at the output.

To prevent noise signal from circulating through ground plates, reference all of the sensitive analog signals to AGND and connect

AGND to PGNDs using only a single point connection. This ensures that the switching currents of the power stage do not flow into the sensitive AGND node.

PWM Power Stage Layout Guidelines

The PWM power stage consists of a MOSFET pair that forms a switch mode output that switches current from PVIN to the load via an LC filter. The ripple voltage on the PVIN pin is caused by the discontinuous current switched by the PWM side MOSFETs. This rapid switching causes voltage ripple to form at the PVIN input, which must be filtered using a bypass capacitor. Place a 10 μ F capacitor as close as possible to the PVIN pin to connect PVIN to PGNDs. Because the 10 μ F capacitor is sometimes bulky and has higher ESR and ESL, a 100 nF decoupling capacitor is usually used in parallel with it, placed between PVIN and PGNDs.

Because the decoupling is part of the pulsating current loop, which carries high di/dt signals, the traces must be short and wide to minimize the parasitic inductance. As a result, this capacitor is usually placed on the same side of the board as the ADN8834 to ensure short connections. If the layout requires that a 10 μ F capacitor be on the opposite side of the PCB, use multiple vias to reduce via impedance.

The layout around the SW node is also critical because it switches between PVIN and ground rapidly, which makes this node a strong EMI source. Keep the copper area that connects the SW node to the inductor small to minimize parasitic capacitance between the SW node and other signal traces. This helps minimize noise on the SW node due to excessive charge injection. However, in high current applications, the copper area may be increased reasonably to provide heat sink and to sustain high current flow.

Connect the ground side of the capacitor in the LC filter as close as possible to PGNDs to minimize the ESL in the return path.

Linear Power Stage Layout Guidelines

The linear power stage consists of a MOSFET pair that forms a linear amplifier, which operates in linear mode for very low output currents, and changes to fully enhanced mode for greater output currents.

Because the linear power stage does not switch currents rapidly like the PWM power stage, it does not generate noise currents.

PCB LAYOUT GUIDELINES

However, the linear power stage still requires a minimum amount of bypass capacitance to decouple its input.

Place a 100 nF capacitor that connects from PVIN to PGNDL as close as possible to the PVIN pin.

Placing the Thermistor Amplifier and PID Components

The thermistor conditioning and PID compensation amplifiers work with very small signals and have gain; therefore, attention must be paid when placing the external components with these circuits.

Place the thermistor conditioning and PID circuit components close to each other near the inputs of Chopper 1 and Chopper 2. Avoid

crossing paths between the amplifier circuits and the power stages to prevent noise pickup on the sensitive nodes. Always reference the thermistor to AGND to have the cleanest connection to the amplifier input and to avoid any noise or offset build up.

EXAMPLE PCB LAYOUT USING TWO LAYERS

Figure 41, Figure 42, and Figure 43 show an example ADN8834 PCB layout that uses two layers. This layout example achieves a small solution size of approximately 20 mm² with all of the conditioning circuitry and PID included. Using more layers and blinds via allows the solution size to be reduced even further because more of the discrete components can relocate to the bottom side of the PCB.

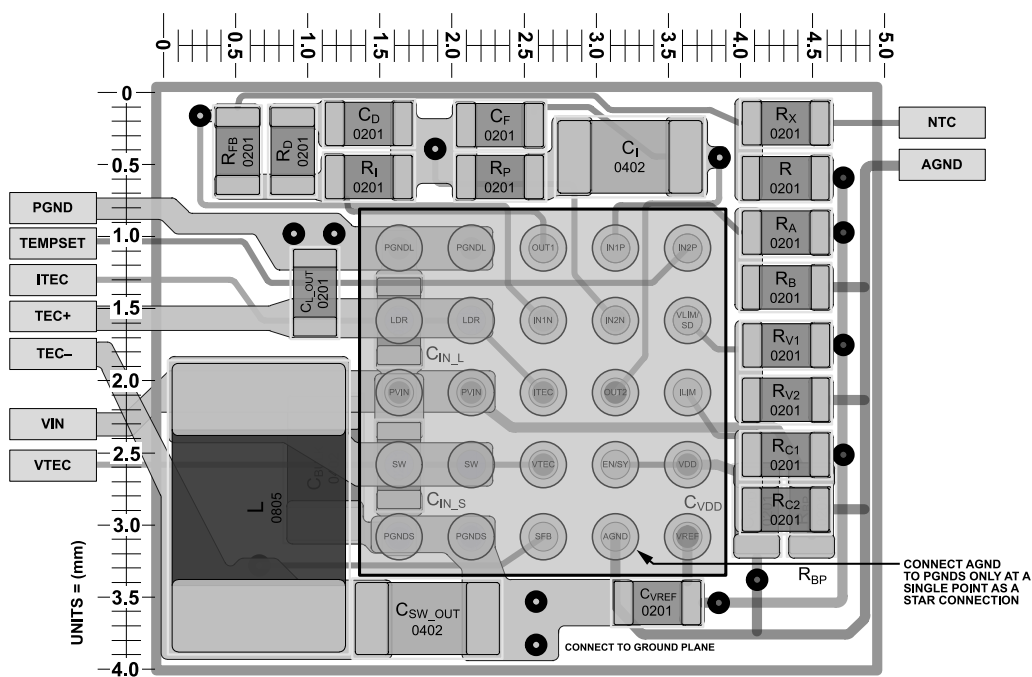

Figure 41. Example PCB Layout Using Two Layers (Top and Bottom Layers)

PCB LAYOUT GUIDELINES

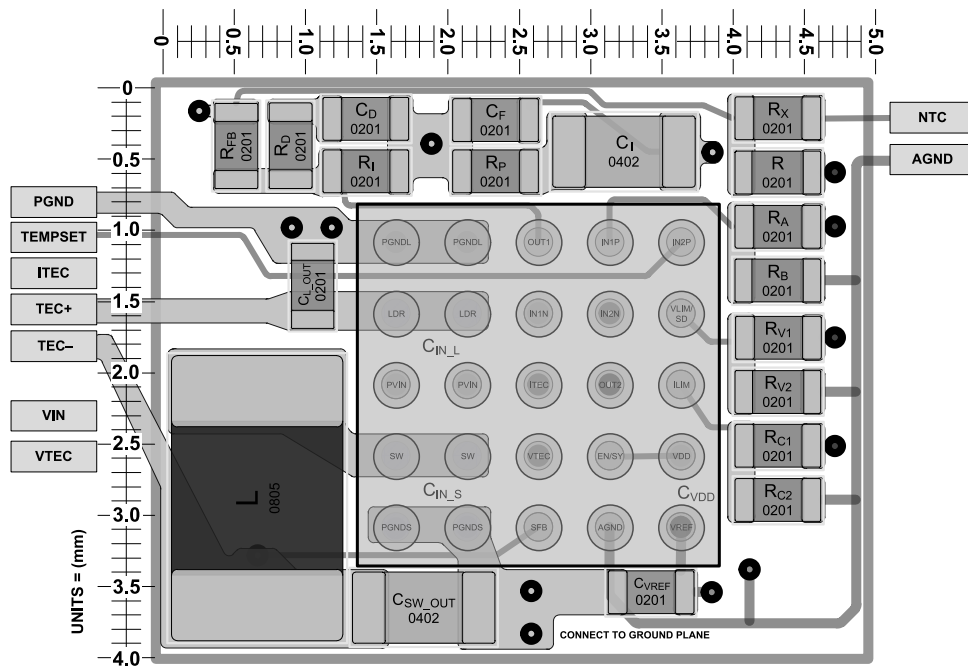

Figure 42. Example PCB Layout Using Two Layers (Top Layer Only)

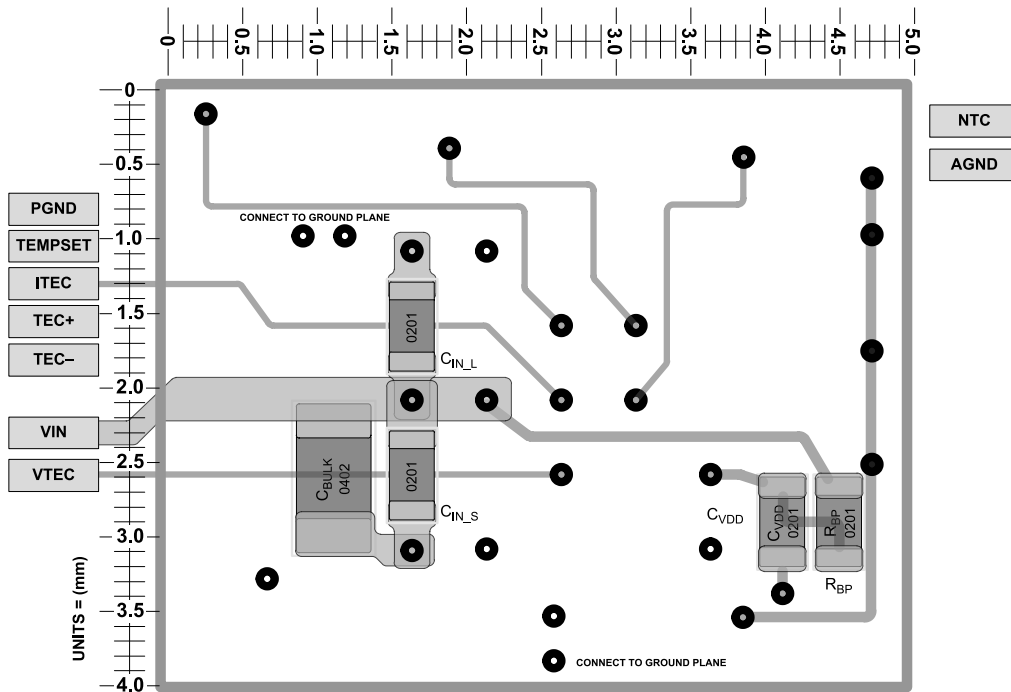

Figure 43. Example PCB Layout Using Two Layers (Bottom Layer Only)

OUTLINE DIMENSIONS

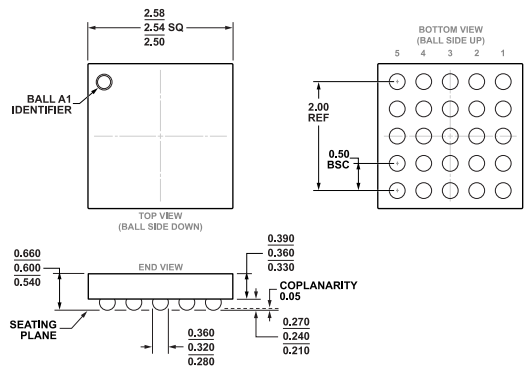

Figure 44. 25-Ball Wafer Level Chip Scale Package [WLCSP] (CB-25-7)
Dimensions shown in millimeters

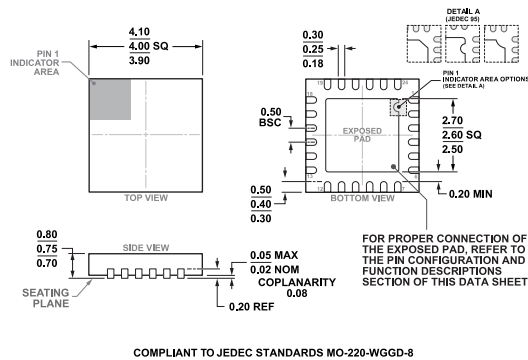

Figure 45. 24-Lead Lead-frame Chip Scale Package [LFCSP] 4 mm x 4 mm and 0.75 mm Package Height (CP-24-15)
Dimensions shown in millimeters

Updated: February 22, 2022

ORDERING GUIDE

Model ^{1,2}	Temperature Range	Package Description	Packing Quantity	Package Option
ADN8834ACBZ-R7	-40°C to +125°C	25-Ball WLCSP (2.54mm x 2.54mm)	Reel, 1500	CB-25-7
ADN8834ACPZ-R2	-40°C to +125°C	24-Lead LFCSP (4mm x 4mm w/ EP)	Reel, 250	CP-24-15
ADN8834ACPZ-R7	-40°C to +125°C	24-Lead LFCSP (4mm x 4mm w/ EP)	Reel, 1500	CP-24-15
ADN8834WACPZ-R7	-40°C to +125°C	24-Lead LFCSP (4mm x 4mm w/ EP)	Reel, 1500	CP-24-15

¹ Z = RoHS Compliant Part.

² W = Qualified for Automotive Applications.

EVALUATION BOARDS

Model ¹	Description
ADN8834CB-EVALZ	25-Ball WLCSP Evaluation Board: ±1.5 A TEC Current Limit, 3 V TEC Voltage Limit
ADN8834CP-EVALZ	24-Lead LFCSP Evaluation Board: ±1.5 A TEC Current Limit, 3 V TEC Voltage Limit
ADN8834MB-EVALZ	Mother Evaluation Board of the ADN8834 for PID Tuning

¹ Z = RoHS Compliant Part.

OUTLINE DIMENSIONS

AUTOMOTIVE PRODUCTS

The ADN8834W model is available with controlled manufacturing to support the quality and reliability requirements of automotive applications. Note that this automotive model may have specifications that differ from the commercial models; therefore, designers should review the [Specifications](#) section of this data sheet carefully. Only the automotive grade product shown is available for use in automotive applications. Contact your local Analog Devices account representative for specific product ordering information and to obtain the specific Automotive Reliability reports for this model.